



S.PRESSO



DO YOU
DO YOU
Do you Do you Do



The Suzuki S-Presso is the perfect extension of you. It allows you to Do You, enabling you take up spaces that you never thought possible. Now, we are giving you the opportunity to take it even further with the NEW & IMPROVED model of the Suzuki S-Presso.

**DO YOU, WITH A
LITTLE EXTRA EDGE
THANKS TO THE
IMPROVED SUZUKI
S-PRESSO. NOW WITH
ADDED FEATURES.**

DO YOU, THE WAY YOU WANT TO.

You can never miss its presence on the road. With a bold design, robust stance that radiates vibrant energy, its attractive SUV styling and 181mm ground clearance, the S-Presso brings alive every place it ventures into. It's a car built for you to take on your own road and do what reflects you. Every drive in the city is a self-expression of the zesty spirit that defines you. Hop into the S-Presso, and do life your way.

Do you Do you Do you





DO BOLD

THE S-PRESSO'S EXTERIOR DESIGN IS A SIGHT TO BEHOLD.

Its bold and athletic profile, combined with its tall and powerful stance ensuring it commands all the attention wherever you go. The car's strong character lines and prominent exterior features, such as the muscular front grille, striking front and rear bumpers, distinct headlamp and rear lamp design add to its charming appearance. Make a bold statement. Do lanes or bends or streets ... or don't. It's up to you.





DO ENERGY

Step inside the S-Presso and have your eyes fall on the unique centre console housing a trendy digital speedometer.



METER CLUSTER

The cutting-edge design gives the car a futuristic look, while ensuring good visibility of the speedometer, allowing you to do you at any speed, on any road. The sharp and sophisticated LED display also gives you all-important details such as instantaneous and average fuel economy, range and more.



COOL NEW TECH YOU'LL LOVE

Introducing the New Generation Touchscreen Infotainment System (GL+) radio which includes vehicle alerts. Thanks to its audio system that lets you enjoy your favourite tunes, you'll love the vibes even more with the smartphone connectivity and reverse camera (S-Edition) which works with Apple CarPlay and Android Auto™. Add to that the Steering-mounted Audio Controls that let you concentrate on navigating the car without any hassle. For the S-Edition, we're pulling up with the stylish 9-inch Infotainment System and S-Edition Exterior Kit.



AIR CONDITIONER AND 12V SOCKET

While enjoying the high-energy drives of the S-Presso, experience the convenience it offers too. Wherever the road takes you, its easy-to-operate manual air conditioner keeps you comfortable, while a 12V socket in the front console lets you charge your devices.





DO PERFORMANCE AND COMFORT

The invigorating experience of the S-Presso is a combination of driving performance and convenience. With a peppy engine and other innovative features, you're free to do fast or slow, uphill or downhill. And because comfort matters, it has a spacious cabin and ample shoulder room. That's not all. A 239 litre luggage compartment provides enough space for multiple items, and if you require more space just fold the rear bench seat.

Sit back, relax and just do you!





DO SPACE

The presence of storage compartments let you stow small items, drinks, make up, wigs or whatever you're into, adding to the comfort of the spacious interiors.

- 1 | Rear console pocket
- 2 | Front console cup holder
- 3 | Door pocket
- 4 | Open tray
- 5 | Glove box
- 6 | Front console pocket

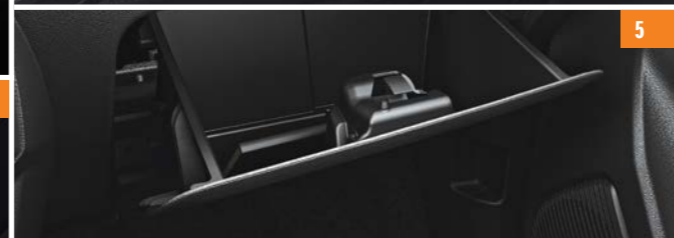

SLICK WHEELS FOR A SLICK DRIVER

Leave a lasting mark when you cruise through the city. The upgraded Suzuki S-Presso is taking its style to a whole new level with its quality 14" alloy wheels, now available with the S-Presso GL+ and S-Edition.

DO MANUAL TRANSMISSION

With a five-speed manual transmission, the S-Presso makes driving on any road a pleasant experience. Its transmission offers an optimal gear ratio and reduces friction for the engine and drivetrain enabling it to obtain the best possible fuel consumption and power performance for whatever you feel like doing.

DO AUTOMATED MANUAL TRANSMISSION

The five-speed (AMT) Automated Manual Transmission features the same convenience and comfort of a conventional automatic transmission - but with excellent performance, improved fuel efficiency and the ability to change gears manually if you prefer to do so.

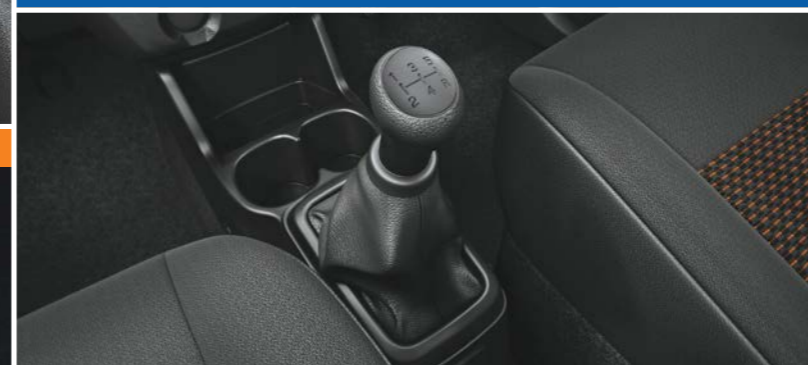

DO YOU SAFELY

The S-Presso lets nothing hinder you from reaching what you set out for. And it does this by keeping you protected on every road you take. The ISOFIX child seat anchorages are now also included so your little one can sit back and enjoy the ride, while being safe and sound.

With a host of exceptional safety features, the S-Presso takes care of you while you enjoy the drive.

HEARTECT NEW-GENERATION “HEARTECT” PLATFORM

Innovation lies at the heart of the S-Presso. It is built with Suzuki’s new-generation platform – HEARTECT. Light and highly rigid, it lowers fuel consumption and vastly improves the fundamental vehicle performance in terms of running, turning and stopping. Its frame is characterised by smooth and continuous curves, which efficiently disperses impact energy in case of a collision.

ABS WITH EBD

ABS helps to keep your wheels from locking, adding stability to any sudden evasive manoeuvres. Electronic Brake force Distribution (EBD) works with ABS to maintain control, by sending the optimum amount of braking force to the front and rear wheels.



IMPROVED PERFORMANCE

The new Dualjet K10C Engine allows you to take to the road with confidence. With that, we’ve added the trusted Engine Auto Stop Start feature to make your drives easier. You can also look forward to improved fuel efficiency, with **4.4ℓ/100km for the automated manual transmission (AMT) and 4.6ℓ/100km for the manual transmission (MT).**

PRE-TENSIONER AND FORCE LIMITER SEATBELTS

The pre-tensioner is designed to tighten the seatbelts to restrain occupants quickly and to prevent them from being thrown forward in case of a moderate or severe frontal crash. Force limiter helps protect occupants from seatbelt inflicted injuries.

ELECTRONIC STABILITY PROGRAM (ESP)

Maintain control of your S-Presso in any driving conditions. ESP is a computer-controlled braking system which maintains traction on the road by controlling individual wheels. ESP enhances safety in slippery road conditions and during sudden, harsh and evasive steering manoeuvres.

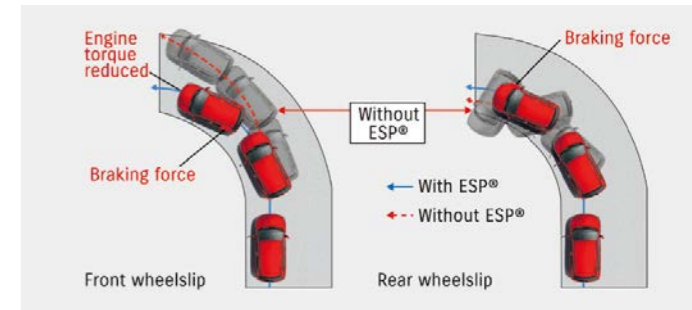

AIRBAGS

All models of the S-Presso come with two front SRS airbags as standard for the safety of both the driver and front-seat passenger in case of a frontal collision.



REAR PARKING ASSIST SYSTEM

S-Presso is fitted with ultrasonic sensors in the rear bumper along with a reverse camera*. This means you can get rid of your parking woes, because it helps detect obstacles while you park the car. Warning sounds keep you aware of the distance to the obstacle while the display from the reverse camera* makes parking a simple task.

*Reverse camera on S-Edition only

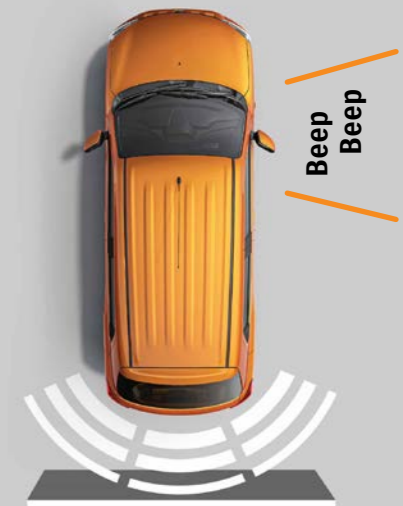

MAJOR SPECIFICATIONS

Engine	Petrol
	1.0ℓ
Drive system	2WD
Number of doors	5-door

DIMENSIONS

Overall length (mm)	3 565	
Overall width (mm)	1 520	
Overall height (mm)	1 567	
Wheelbase (mm)	2 380	
Tread	Front (mm)	1 316
	Rear (mm)	1 318
Minimum turning radius (m)	4.5	
Minimum ground clearance (mm)	181	

CAPACITIES

Seating capacity	5 persons	
Luggage capacity - high variant with parcel shelf	Maximum volume	239ℓ
Fuel tank capacity	27ℓ	

ENGINE

Type	K10C
Number of cylinders	3
Number of valves	12
Piston displacement (cm ³)	998
Bore x stroke (mm)	73.0 x 79.5
Compression ratio	11.5
Maximum output (kW/rpm)	49 / 5 500
Maximum torque (N-m/rpm)	89 / 3 500
Fuel distribution	Multipoint injection
Comparative fuel (ℓ/100km)	4.4 AMT & 4.6 MT
Comparative CO ² emissions (g/km)	105 (1.0 MT) & 100 (1.0 AMT)

TRANSMISSION

Type	5MT	AGS	
Gear ratio	1 st	3.545	3.545
	2 nd	1.864	1.864
	3 rd	1.240	1.240
	4 th	0.906	0.906
	5 th	0.718	0.697
	Reverse	3.273	3.273
Final gear ratio	4.471	4.706	

CHASSIS

Steering	Rack and Pinion	
Brakes	Front	Ventilated disc
	Rear	Drum
Suspension	Front	MacPherson strut
	Rear	Torsion beam
Tyres and wheels	165/70R14	

WEIGHTS

Kerb weight (minimum/with full option) (kg)	765/779
Gross vehicle weight (kg)	1 170

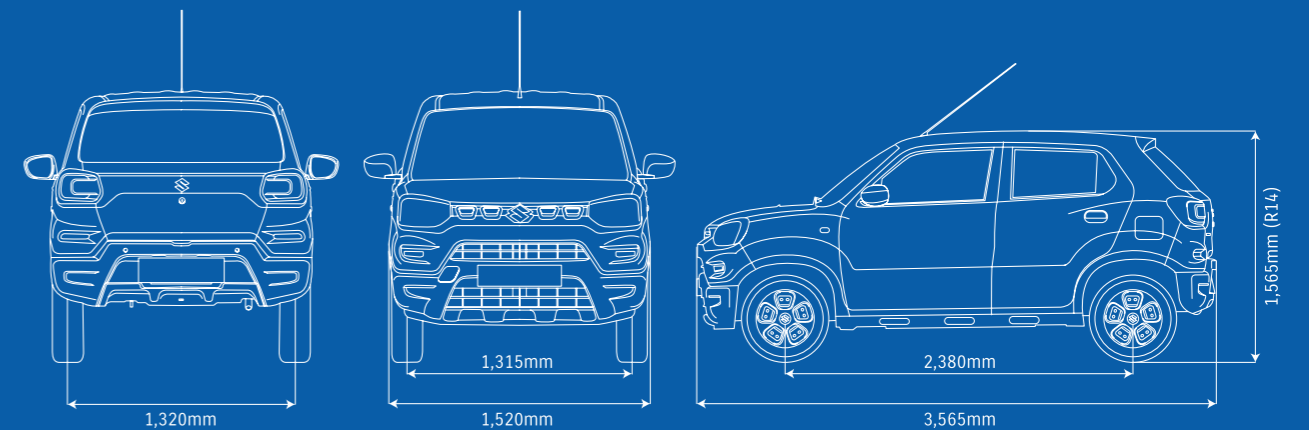

MAJOR EQUIPMENT

GRADE	GL	GL+	S-Edition
TRANSMISSION	5MT/AMT	5MT/AMT	5MT/AMT

CHASSIS

Tyres and wheels	165/70R14 + steel wheels (full wheel cover)	⊕	-	-
	165/70R14 + alloy wheels	-	⊕	⊕
Spare tyre and wheel	165/70R14 + steel wheel	⊕	⊕	⊕

EXTERIOR

Bumper	Body coloured	⊕	⊕	⊕
Front grille	Black	⊕	⊕	⊕
Outside door handles	Body coloured	⊕	⊕	⊕
Tailgate opener	Key-cylinder type and inside tailgate lever	⊕	⊕	⊕

VISIBILITY

Headlamps	Halogen multireflector	⊕	⊕	⊕
Position lamps		⊕	⊕	⊕
Rear combination lamps		⊕	⊕	⊕
Green-tinted windows		⊕	⊕	⊕
Wipers	Front: 2-speed (low, high) + intermittent + washer	⊕	⊕	⊕
Rear window demister (back door defogger)		⊕	⊕	⊕
Outside door mirrors	Body coloured	⊕	⊕	⊕
	Manual adjust bar	⊕	⊕	⊕
Day/night rearview mirror	Manual dimming	⊕	⊕	⊕

STEERING AND INSTRUMENT PANEL

3-spoke steering wheel	Urethane	⊕	⊕	⊕
	With audio controls	⊕	⊕	⊕
	With hands-free phone control	⊕	⊕	⊕
Power steering		⊕	⊕	⊕
Information display integrated info meter cluster	Fuel consumption	⊕	⊕	⊕
	Driving range (distance to empty)	⊕	⊕	⊕

GRADE	GL	GL+	S-Edition
TRANSMISSION	5MT/AMT	5MT/AMT	5MT/AMT

STEERING AND INSTRUMENT PANEL (CONTINUED)

Light-off and key reminder		⊕	⊕	⊕
Driver's seatbelt reminder	Lamp and alarm	⊕	⊕	⊕
Passenger's seatbelt reminder	Lamp and alarm	⊕	⊕	⊕
Meter illumination		⊕	⊕	⊕
Centre and side louvre bezels	Black	⊕	⊕	⊕

DRIVING AMENITIES

Electric windows	Front	⊕	⊕	⊕
Central door locking	Switch on driver's side	⊕	⊕	⊕
Remote controlled door locks	With hazard lamp answerback function	⊕	⊕	⊕
Air conditioner	Manual	⊕	⊕	⊕
Heater		⊕	⊕	⊕
Audio	Antenna	⊕	⊕	⊕
	Front speakers	2	2	2
	7" touchscreen radio + Bluetooth®*	-	⊕	-
	9" touchscreen radio + Bluetooth®*	-	-	⊕
	Reverse camera	-	-	⊕

INTERIOR

Cabin lights	Front cabin light (3-position)	⊕	⊕	⊕
Sun visors	Driver's side	⊕	⊕	⊕
	Passenger's side	⊕	⊕	⊕
Assist grips	Passenger's side	⊕	⊕	⊕
	Rear x 2	⊕	⊕	⊕
Cup holder	Front x 2	⊕	⊕	⊕
Bottle holder	Front x 2	⊕	⊕	⊕
USB Port	Front console	-	⊕	⊕
12V accessory socket	Front console	⊕	⊕	⊕
Remote fuel lid opener		⊕	⊕	⊕
Inside door handles	Black	⊕	⊕	⊕
Storage pockets	Front door	⊕	⊕	⊕

MAJOR EQUIPMENT (CONTINUED)

GRADE	GL	GL+	S-Edition
TRANSMISSION	5MT/AMT	5MT/AMT	5MT/AMT

SEATS

Front seats	Head restraints (integrated type)	◆	◆	◆
Rear seats	Bench seat	◆	◆	◆
	Neck rests x 2 (separate type)	◆	◆	◆
Seat upholstery material	Vinyl + fabric	◆	◆	◆

LUGGAGE AREA

Luggage shelf	◆	◆	◆
---------------	---	---	---

SAFETY AND SECURITY

ABS		◆	◆	◆
ESP ^{®**}		◆	◆	◆
Hill hold control	AMT only	◆	◆	◆
Parking sensors	Rear	◆	◆	◆
SRS front dual airbags		◆	◆	◆
Seatbelts	Front: 3-point ELR seatbelts with pretensioners and force limiters	◆	◆	◆
	Rear: 3-point ELR seatbelts (side x 2) 2-point lapbelt (centre)	◆	◆	◆
ISOFIX lower anchorages		◆	◆	◆
ISOFIX top tether anchorage		◆	◆	◆
Childproof rear door locks		◆	◆	◆
Immobiliser		◆	◆	◆

◆: Standard - : Not available

*: Bluetooth is a registered trademark of Bluetooth SIG, Inc.

** : ESP is a registered trademark of Daimler AG.

The ESP is designed to help keep the vehicle under control. However, the degree of engine torque reduction, the wheels that brake and their braking force vary according to the driving conditions.

ESP[®] is essentially a system to assist stable driving. In the case of slippage or skidding that exceeds the limits of grip between tyres and road surface, ESP[®] will still function but may not be effective.



Do you Do you Do you Do you

Do Style

Personalize your S-Presso with the trend-setting range of accessories and make it distinctive with a head-turning road presence.

EXTERIOR ACCESSORIES

- 1 | **Front Skid Plate**
Part No. 990J0M62S07-220
- 2 | **Rear Skid Plate**
Part No. 990J0M62S07-020
- 3 | **Side Skid Plate**
Part No. 990J0M62S07-050
- 4 | **Rear Upper Spoiler**
White
Part No. 990J0M62S07-130
Silver
Part No. 990J0M62S07-140
Red
Part No. 990J0M62S07-150
Grey
Part No. 990J0M62S07-160
Orange
Part No. 990J0M62S07-170
Blue
Part No. 990J0M62S07-180
OC Black
Part No. 990J0M62S07-190

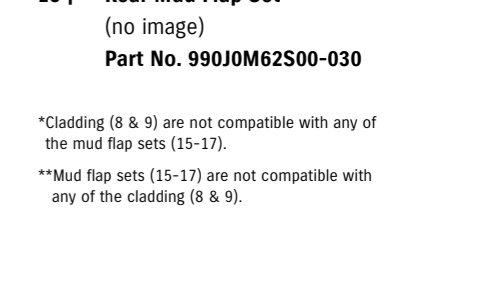
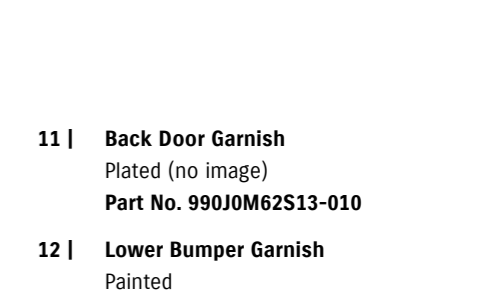
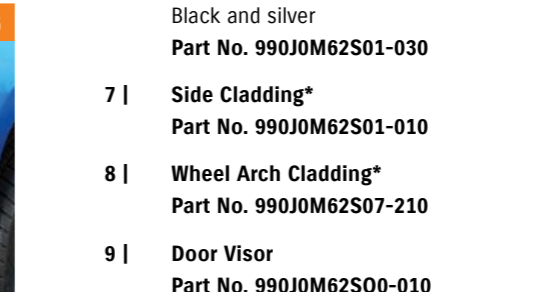

- 5 | **Rear Upper Garnish**
Part No. 990J0M62S07-200
- 6 | **Body Side Moulding**
Black and orange
Part No. 990J0M62S01-020
Black and silver
Part No. 990J0M62S01-030
- 7 | **Side Cladding***
Part No. 990J0M62S01-010
- 8 | **Wheel Arch Cladding***
Part No. 990J0M62S07-210
- 9 | **Door Visor**
Part No. 990J0M62SQ0-010
- 10 | **Upper Grille Garnish**
Chrome
Part No. 990J0M62S13-170
White
Part No. 990J0M62S13-050
Blue
Part No. 990J0M62S13-120
Red
Part No. 990J0M62S13-130
Silky Silver
Part No. 990J0M62S13-140
Granite Grey
Part No. 990J0M62S13-150
Orange
Part No. 990J0M62S13-160

- 11 | **Back Door Garnish**
Plated (no image)
Part No. 990J0M62S13-010
- 12 | **Lower Bumper Garnish**
Painted
Part No. 990J0M62S13-030
- 13 | **Mud Flap Set****
(no image)
Part No. 990J0M62S00-010
- 14 | **Front Mud Flap Set****
(no image)
Part No. 990J0M62S00-020
- 15 | **Rear Mud Flap Set****
(no image)
Part No. 990J0M62S00-030

*Cladding (8 & 9) are not compatible with any of the mud flap sets (15-17).

**Mud flap sets (15-17) are not compatible with any of the cladding (8 & 9).

INTERIOR ACCESSORIES

- 1 | **Deluxe Carpet Mat**
Part No. 75901M62S10-000
- 2 | **Center Console and AC Vent**
Silver
Part No. 990J0M62SPJ-020
Orange
Part No. 990J0M62SPJ-040
Red
Part No. 990J0M62SPJ-070
Blue
Part No. 990J0M62SPJ-080
- 3 | **Door Ornament**
Silky Silver
Part No. 990J0M62SPJ-010
Orange
Part No. 990J0M62SPJ-030
Red
Part No. 990J0M62SPJ-050
Blue
Part No. 990J0M62SPJ-060
- 4 | **Rear Parcel Tray**
(no image)
Part No. 990J0M62S08-010
- 5 | **Dool Sill Guard**
Part No. 990J0M62SP6-010
- 6 | **Dool Sill Guard**
Part No. 990J0M62SP6-020

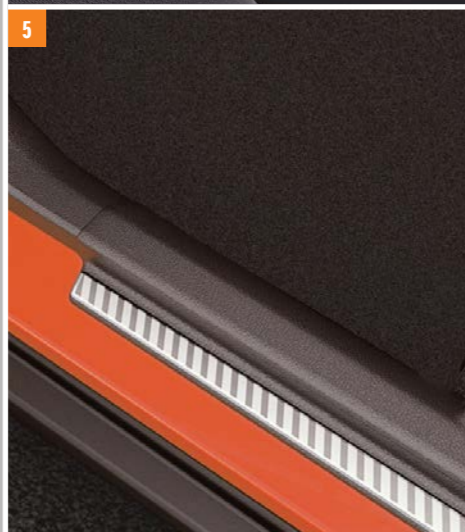



S-PRESSO COLOURS



Sizzle Orange Z2T



Starry Blue Pearl Z2S



Fire Red Z4Q



Granite Grey Metallic ZTN



Silky Silver Metallic Z2S



White 26U

TRAPEZOID DESIGNED WHEELS



14-INCH STEEL WHEEL (FULL WHEEL COVER)



14-INCH ALLOY WHEEL



SUZUKI

COMPLETE

Suzuki understands that purchasing a new vehicle is a substantial investment. Our unwavering commitment to customer satisfaction is represented in our 'Suzuki Complete' package, which includes every aspect of after-sales support, with warranty, service plan, and roadside assistance standard.

Warranty

All Suzuki models are covered by a promotional comprehensive manufacturer's warranty against any defects for a period of 5-year/200 000km. This is supported by a six-year body corrosion warranty subject to terms and conditions. The comprehensive manufacturer's warranty is strictly reserved to new passenger cars purchased at Suzuki dealerships nationwide.

Service Plan

The Suzuki S-Presso benefits from a 2-year/30 000km service plan. This plan includes the replacement of oil, the oil filter, fuel filter, brake fluid, air filter and accessory belts, but excludes tyres, brakes and other wear-and-tear items.

Service Intervals

15 000km or one year, whichever comes first.

Roadside Assistance

Every new S-Presso comes with a roadside assistance plan. Some of the benefits offered by this comprehensive package include: battery and locksmith call-out services, mechanical and electrical, breakdown towing (accident towing is optional), emergency medical rescue, vehicle repatriation and a stand-by-you roadside security armed-response service.

All care is taken to ensure the accuracy of this brochure at the time of print approval. Specifications, features, prices and model availability may vary from those specified and may change without notice. Always consult your authorised Suzuki Dealer or refer to www.SuzukiAuto.co.za for the latest details on all models. SUZUKI AUTO South Africa (PTY) Ltd will not be held liable for any loss as a result of reliance on the content of this brochure, whether in negligence or otherwise. Vehicles are shown for illustrative purposes only and may not depict exact specifications. Published December 2022.

Part number 9900L-66S02-BR0



SUZUKI AUTO SOUTH AFRICA (PTY) LTD | Tel: 0861 511 111
No.52 Saturn Crescent, Linbro Business Park, Frankenwald, Marlboro, Sandton
www.SuzukiAuto.co.za

